

**Important words to know when sharing
the Gospel in a foreign language**

God	created (made)
earth (world)	said
tree/s	not eat
man (people)	ate
Adam	disobeyed
fruit	sin (do wrong)
sinful (bad)	separated
we / us	loves
you	came
Jesus	born
friend/s	crucified
cross	died
tomb (cave)	put (placed)
clouds	alive
heaven	went
heart	reigns
Bible	pray
but	forgive
.....	make
		new (clean)
		will come
		take
	



Gospel on a Page

God's creation and redemption of man

Features

- Easy and cheap to make! Needs only two sheets of paper (card), scissors and glue to construct.
- Symbolic pictures are changed and moved throughout the presentation (the picture is not static).
- From creation to the return of Jesus is depicted on a single page.
- The *Gospel on a Page* can be used in any language. There are no written words on the picture sheet.

Printing guideline

- Use normal white paper or cardstock. The objects can be printed in color or black and white. Black and white prints can be colored with marker pens or shaded with pencils.
- Laminate the Gospel page and objects.
- For best results with gluing, use clear adhesive and spread with a match stick.

Using the page

- It is best to mount the picture card upright for use with a small group, or lay it flat when using it one-on-one.
- Begin with the cut-outs in their initial positions.
- Explain the Gospel simply and in your own words.
- Allow the child/ren to ask questions by pointing to something that may not be clear. Let the child retell the story using the objects.

1. Cut out the cloud and glue it in position with a little glue at both ends.
2. Glue on clear plastic strips (tabs) as shown. Cut strips from a empty pouch that has been laminated or a clear cover sheet (used for ring binding). Use clear adhesive.
3. Wait for a number of hours for the glue to dry before using. Once dry, bend the top of the tabs out a little.

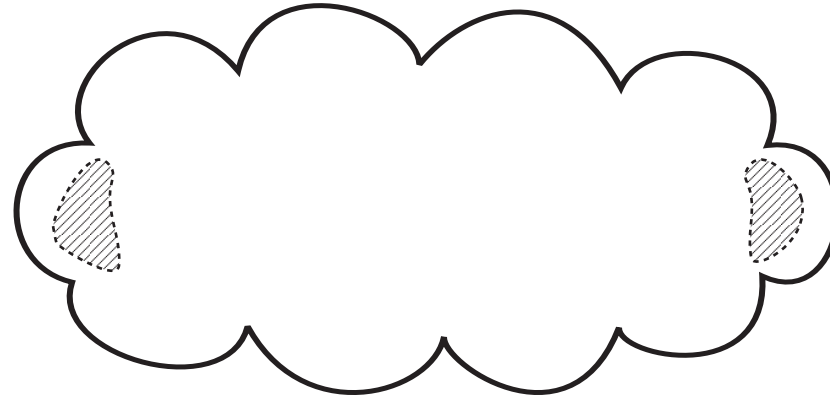

Plastic strip

Clear adhesive

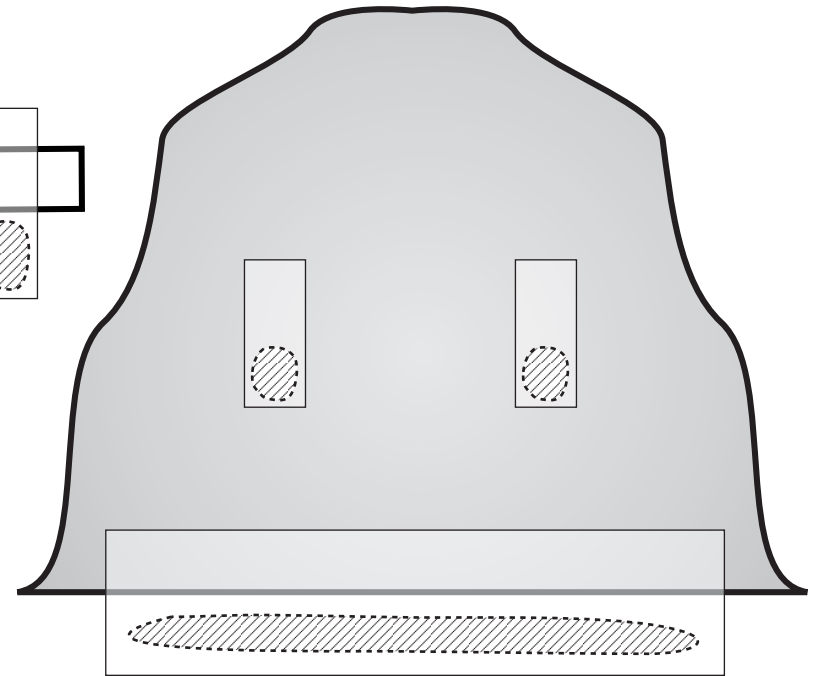
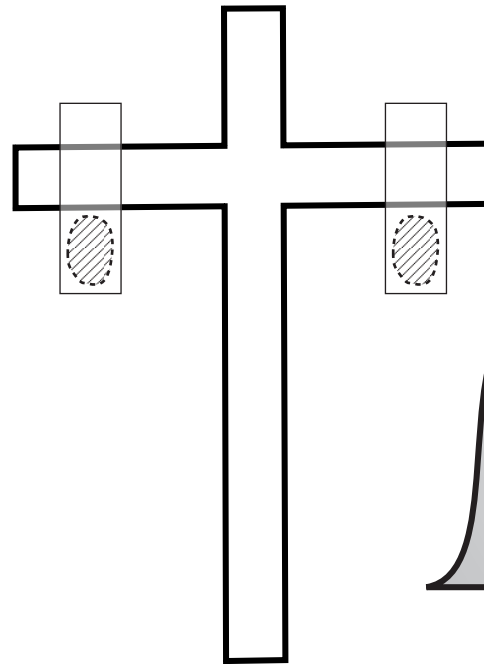
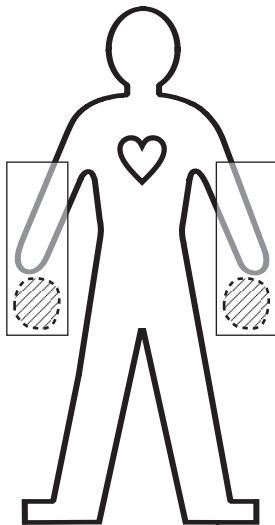
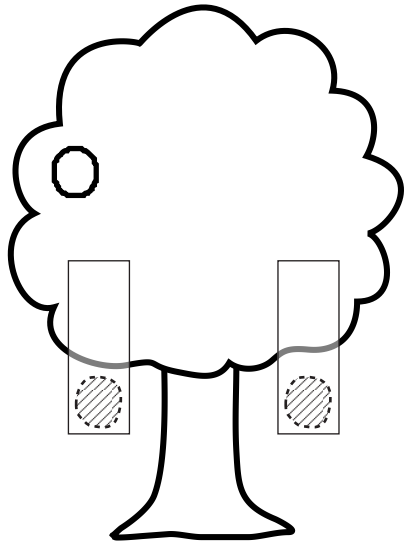

Step-by-step instructions for animation

① **God created everything that exists**--the universe, the world and nature. He also created man. God made the first man and woman, Adam and Eve, absolutely perfect--just as He is. Genesis 1:26-27.

** Set up the board as shown in #1*

② **God told Adam not to eat of the fruit of the tree in the middle of the garden.** But Adam and Eve disobeyed God and ate the fruit, and sin entered the world. Genesis 2:17, Genesis 3:6-7, Isaiah 59:2.

** Remove the fruit (triangle) from the tree, flip it around and place the sinful heart on the man.*

** Slide in the sin barrier to show that sin separates man from God.*

③ **God sent Jesus to earth.** Jesus was born as a baby on earth. When Jesus was a man He went around telling people about God and doing good. Jesus showed us God's love. John 3:16, Luke 2:4-7, Matthew 9:35.

** Position the figure of Jesus next to the man by sliding the arm in behind the man.*

④ **Jesus was crucified.** There were bad, jealous men that hated Jesus so much that they nailed Him to a cross. Yet this was God's plan - the only way for Him to get rid of sin. A sinless person had to take the blame and the punishment for the world's sin. Only Jesus could. Mark 15:25-39, Isaiah 53:6, 1 Peter 3:18.

** Place the figure of Jesus on the cross (supported by the glued strips). Remove the sin barrier and place it on Jesus.*

⑤ **Jesus died and was buried.** Jesus died on the cross for our sins--so that we can have Life. After Jesus had died,

⑥ friends put His body in a tomb. Romans 5:17,

⑦ John 19:38-42.

** Take the figure of Jesus and the sin barrier down.*

** Remove the front of the tomb.*

** Place the sin barrier in the tomb (in its holder).*

** Place the figure of Jesus in the tomb (supported by the strip at the bottom of the tomb).*

⑧ **A stone was rolled across the entrance of the tomb.** The tomb was sealed and Roman guards were put there. Matthew 27:59-60, Matthew 27:65-66.

⑨ ** Flip the picture of the tomb around to show the stone in front of the entrance. Secure the picture between the top and bottom strips.*

⑩ **Jesus rose from the dead.** On the third day God raised Jesus from the dead. Matthew 28:1-7

** Remove the front of the tomb.*

** Take the figure of Jesus out but leave the sin barrier.*

⑪ **The stone was rolled away.**

** Flip the tomb picture around (showing the stone rolled away) and place it back in its position.*

⑫ **Jesus returned to heaven.** Jesus spoke to His disciples and told them to spread the Good News. Then He lifted up into heaven where He sits on the right side of His Father. John 20:20, Acts 1:8-11, Colossians 3:1.

** Show how Jesus ascended into heaven by moving the figure of Jesus up and behind the cloud. Remove the figure at the top.*

Jesus can take away our sin and give us eternal life.

If you ask Jesus to forgive you and make your heart new, He will come and live in you and give you eternal life.

1 John 1:9, John 6:47, Romans 6:22.

** Remove the sinful heart from the man to show a pure heart.*

Jesus will come back in the clouds. Show Jesus in the cloud (on top). 1 Thessalonians 4:17.

1. God created the universe, the world and man.
2. God had a close friendship with Adam and Eve.

1

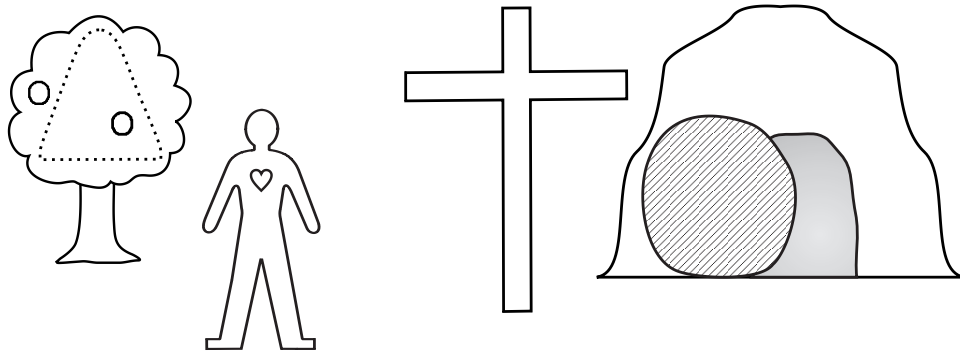

1. God told Adam not to eat of the fruit.
2. Adam and Eve disobeyed God.
3. Sin came into the world.

2

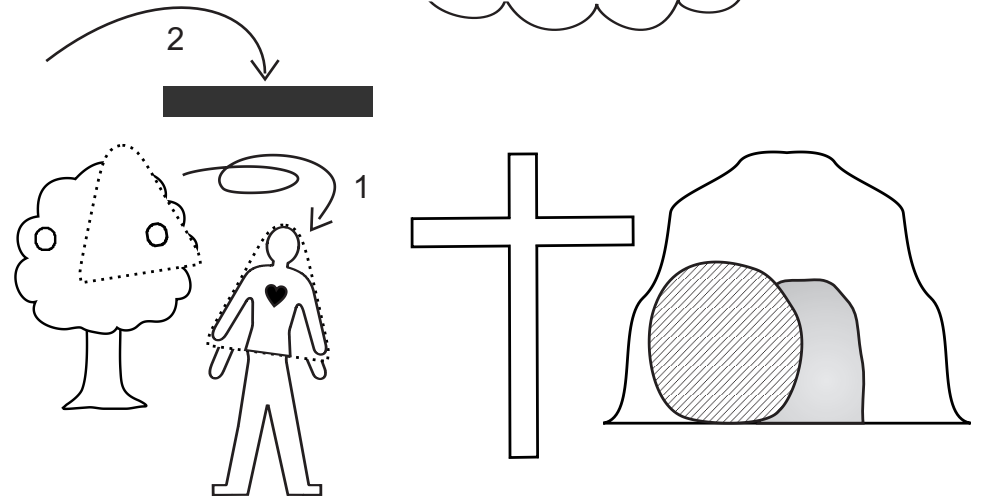

1. God sent His Son Jesus to earth.
2. Jesus was born of the Holy Spirit.
3. Jesus came as the friend of sinners.

3

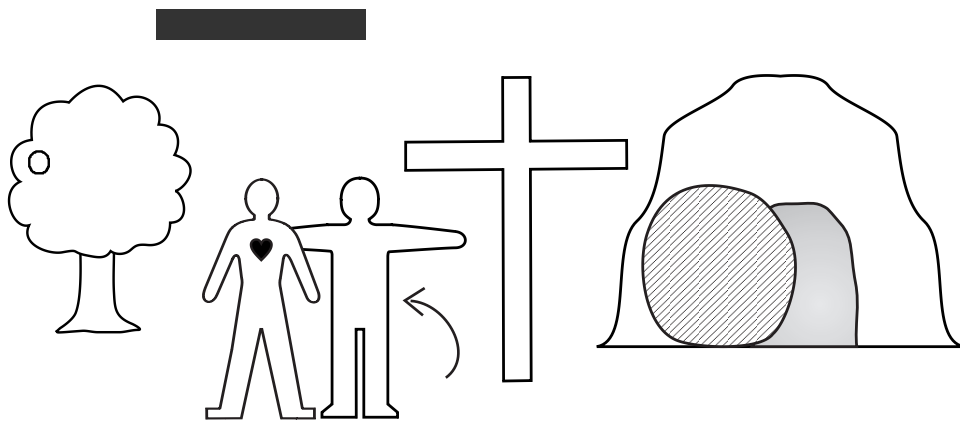

1. Bad people put Jesus on a cross.
2. Jesus took the sin of the world on Him.
3. Jesus died on the cross.

4

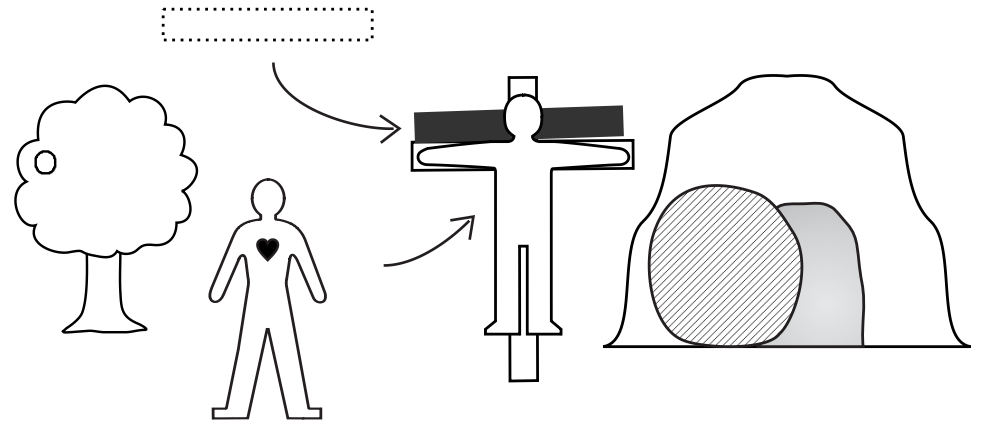

5

1. Friends of Jesus put His body in a tomb.

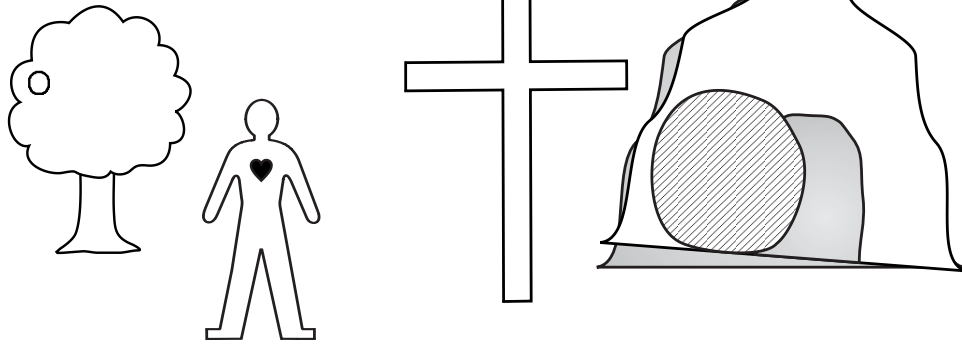

6

1. The sin of the whole world was paid for.

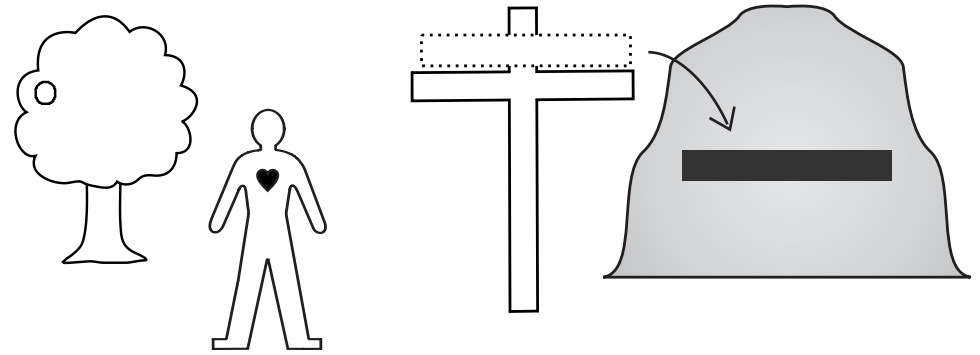

7

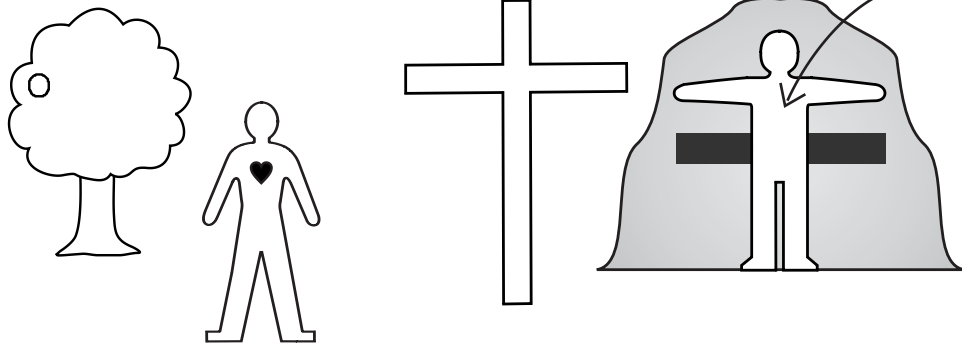
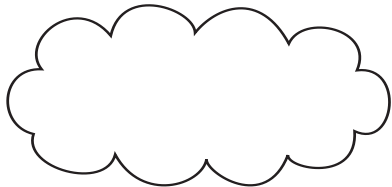

8

1. A large stone was rolled across the entrance.

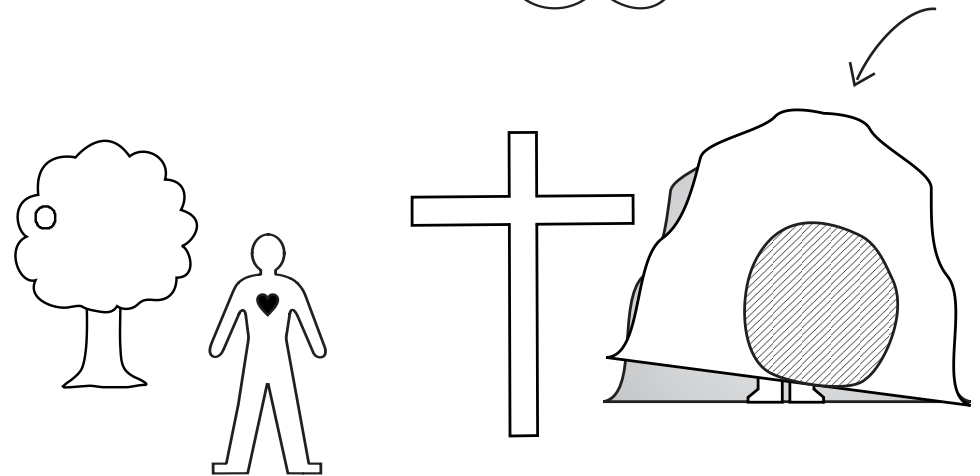

9

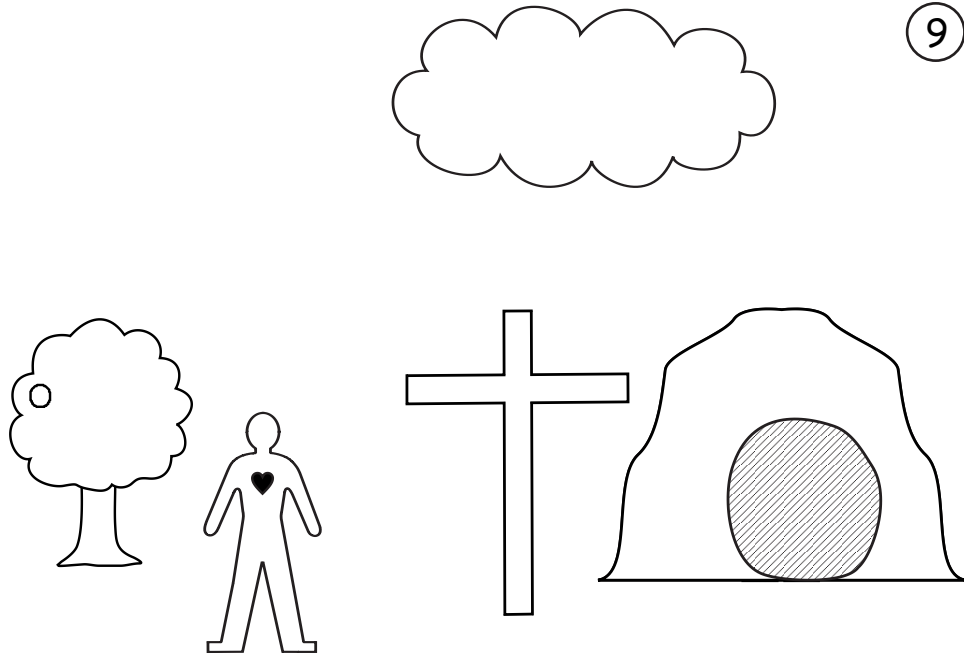

10

1. On the third day, an angel rolled away the stone.
2. God raised Jesus from the dead.
3. Jesus was alive again!

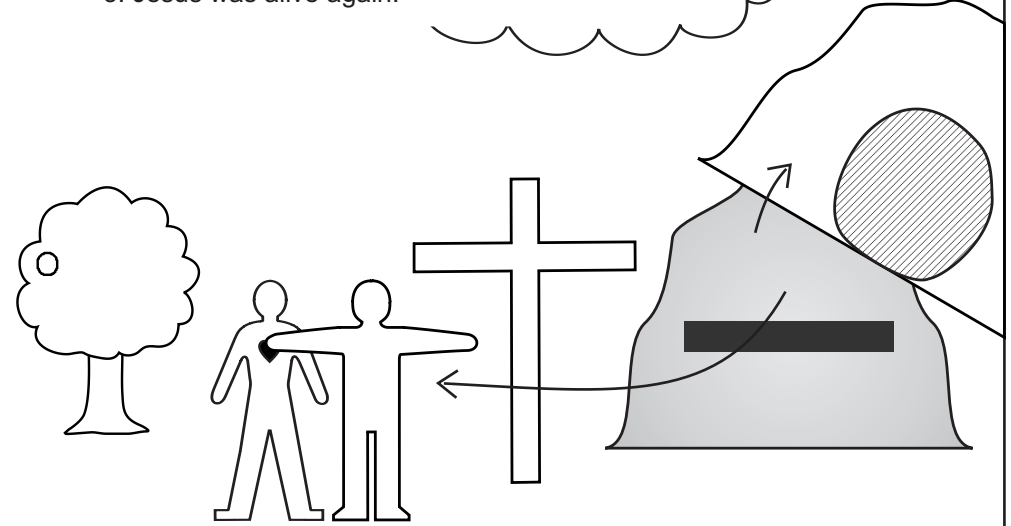

11

1. Jesus showed Himself to His friends.
2. He told His followers to spread the Good News.

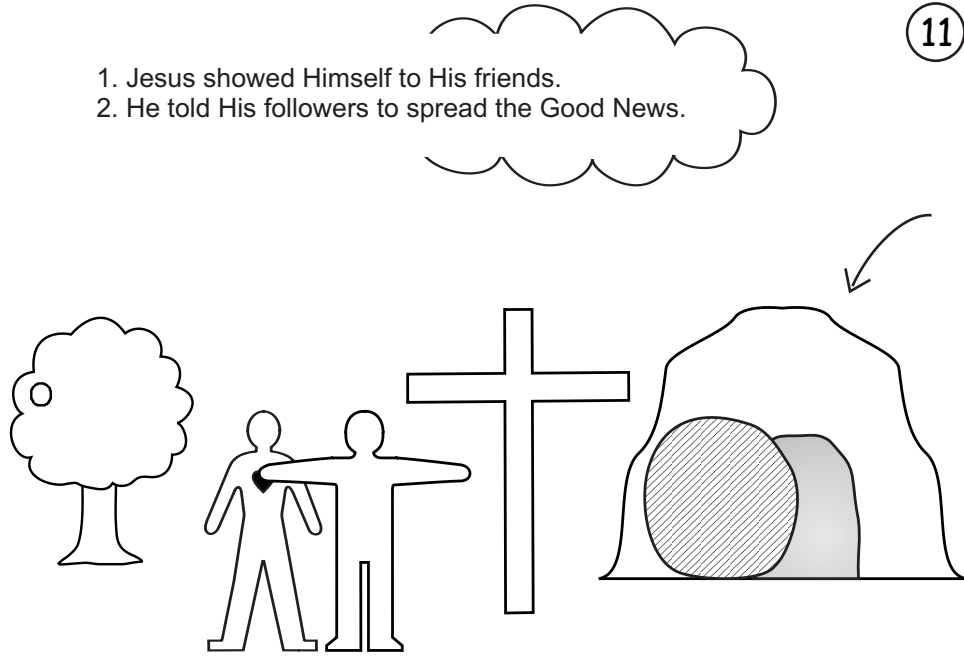

12

1. Then Jesus went up into the sky (clouds).
2. Now, Jesus is next to God in heaven.
3. If you ask Jesus to forgive you, He will take away your sin.

